

HL9565 Broadband Pick-off Tee (50 GHz)

Features and Technical Specifications

PRODUCT SUMMARY

The HL9565 is a pick-off tee with a flat frequency response from DC to 50 GHz on the thru and pick-off lines.

It is suitable as a trigger source with minimum perturbation of the thru signal path.

Digital oscilloscope applications include pre-scaler triggering, synchronization, and clock/data recovery.

DEPLOYMENT NOTES

All specifications contained herein are typical unless otherwise noted.

Some of the data herein are applicable only to matched pairs of devices, and are labeled accordingly.

S-parameter files and higher resolution versions of the plots on the following pages are available on our website.

PRODUCT OPTIONS

The following options and configurations are available for this product:

- M, matched pair
- U, unmatched part(s)

-14, 14 dB nominal insertion loss on pick-off

-20, 20 dB nominal insertion loss on pick-off

-JJJ, jack (female), all ports

-JPJ, jack (female) thru in and pick-off; plug (male) thru out .

Bandwidth	DC to 50 GHz, thru and pick-off lines
Insertion Loss (opt. -14)	0.9 (+ 0.1, -1.25) dB to 50 GHz, thru 14.5 (± 2) dB to 50 GHz, pick-off See Fig. 2
Insertion Loss (opt. -20)	0.45 (+0.1, -1.25) dB, to 50 GHz, thru 20.5 (± 3) dB to 50 GHz, pick-off See Fig. 3
Return Loss	< 13 dB, thru; < 3.5 dB, pick-off (opt. -14) < 12 dB, thru; < 1.75 dB, pick-off (opt. -20) See Figs. 6-7
Amplitude Match (opt. -M only)	± 0.1 dB See Figs. 4-5
Phase Match (opt. -M only)	± 2° at 10 GHz
Rise Time (10-90%)	7 ps, thru and pick-off
Group Delay	≈ 130 ps, thru line (all options) ≈ 137 ps, pick-off line (all options) See Figs. 8-9
Max. Input Power	2 W (+33 dBm) (opt. -14) 4 W (+36 dBm) (opt. -20)
Impedance (Thru In/Out)	41.7 Ω, nominal DC (opt. -14) 45.5 Ω, nominal DC (opt. -20)
Pick-off Resistor	200 Ω ± 2% (opt. -14) 450 Ω ± 2% (opt. -20)
Connectors (thru in / thru out / pick-off)	2.4 mm jack/jack/jack (config. -JJJ) 2.4 mm jack/plug/jack (config. -JPJ)
Unit Dimensions	32.69 x 24.23 x 13.59 mm 1.29" x 0.95" x 0.54"
Unit Weight	15 g (0.48 oz.)
Temperature Limits	-40° to +40° C, operating
RoHS Compliance	RoHS compliant, assembled with lead-free solder

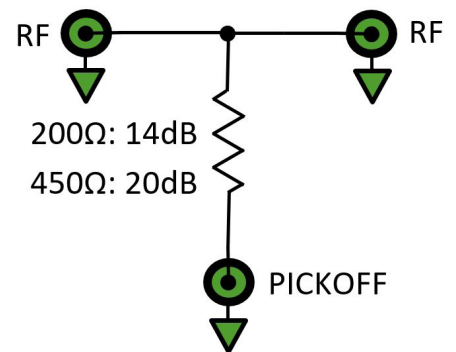

Fig. 1: Schematic of HL9565

HL9565 Insertion Loss

Figure 2 shows the typical insertion loss of an HL9565 -U-14-JJJ along the thru and pick-off lines from DC to 50 GHz.

Figure 3 shows the same measurements for an HL9565-U-20-JJJ.

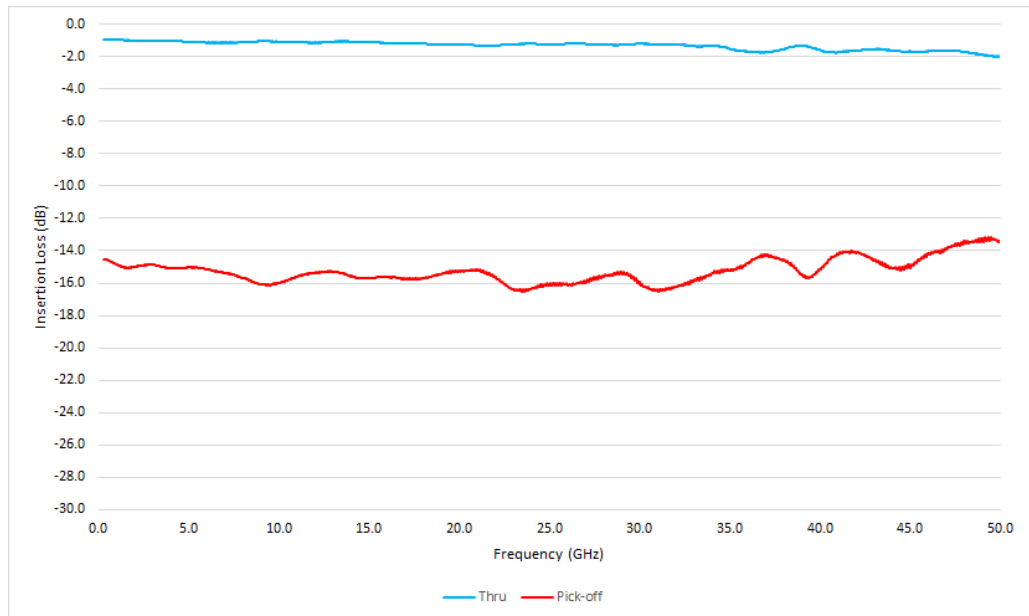

Figure 2: Typical HL9565-U-14-JJJ insertion loss along the thru and pick-off lines

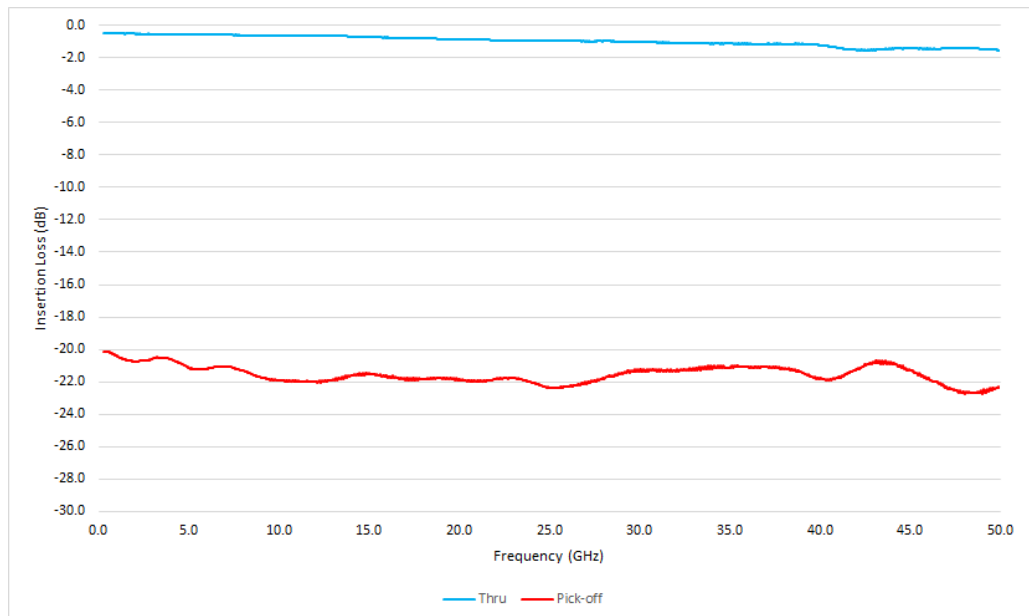

Figure 3: Typical HL9565-U-20-JJJ insertion loss along the thru and pick-off lines

HL9565 Amplitude Match

Figure 5 shows the amplitude match of two matched HL9565-M-14-JJJ devices along the thru and pick-off lines from DC to 50 GHz.

Figure 6 shows the same measurements on two matched HL9565-M-20-JJJ devices.

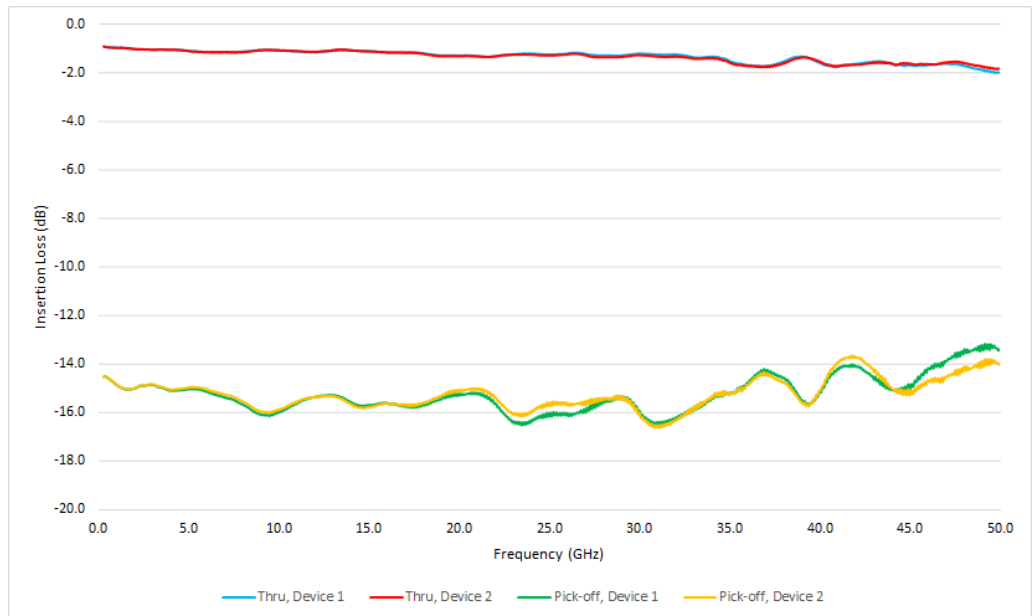

Figure 4: Typical HL9565-M-14-JJJ amplitude match along the thru and pick-off lines

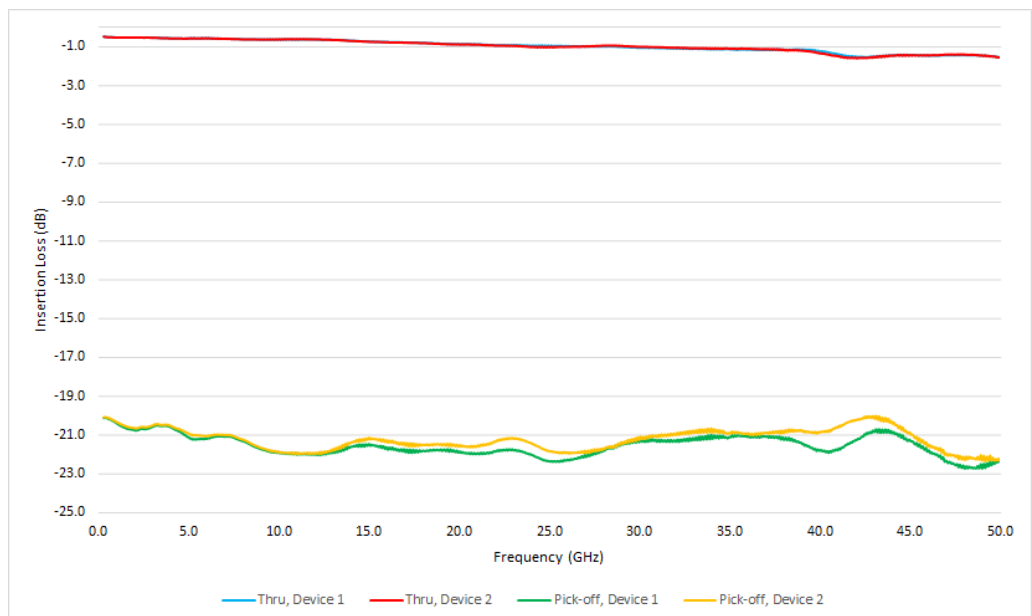

Figure 5: Typical HL9565-M-20-JJJ amplitude match along the thru and pick-off lines

HL9565 Return Loss

Figure 6 shows the typical return loss for all ports of an HL9565-U-14-JJJ from DC to 50 GHz.

Figure 7 shows the same measurements on an HL9565-U-20-JJJ.

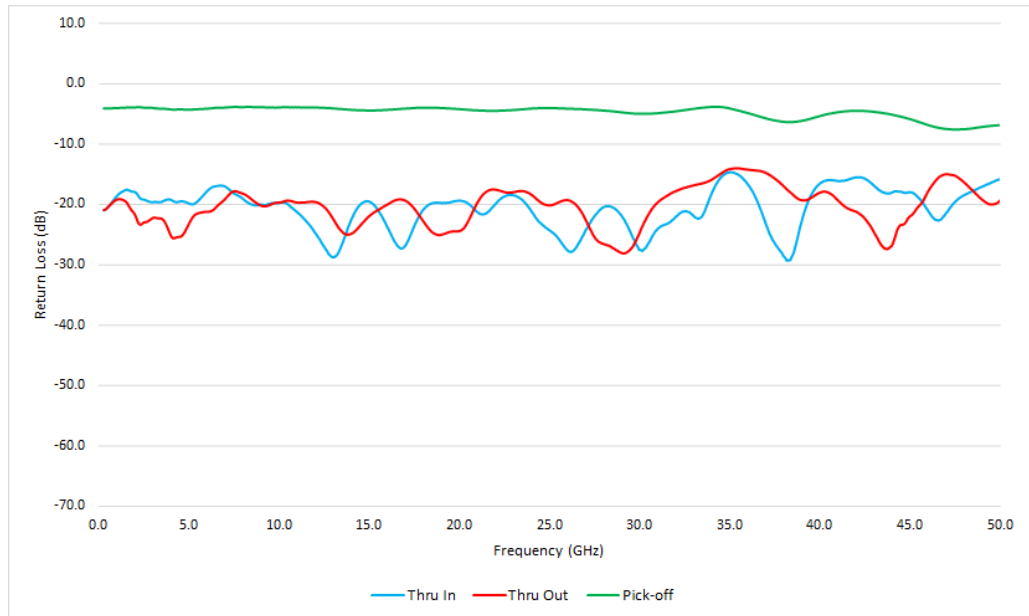

Figure 6: Typical HL9565-U-14-JJJ return loss on all ports

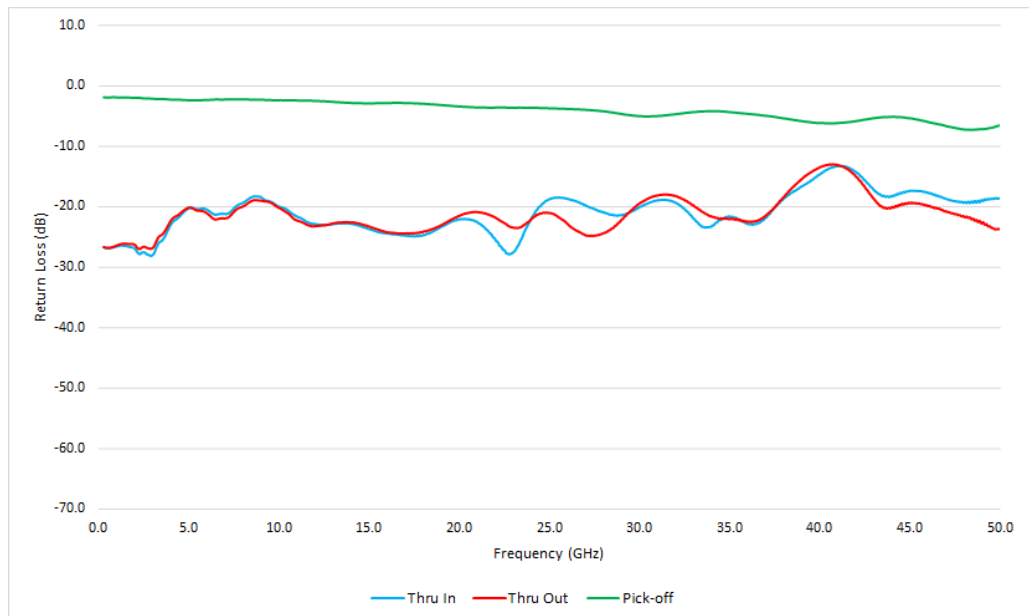

Figure 7: Typical HL9565-U-20-JJJ return loss on all ports

HL9565 Group Delay

Figure 8 shows the typical group delay of the HL9565-U-14-JJJ along the thru and pick-off lines from DC to 50 GHz.

Figure 9 shows the same measurements on an HL9565-U-20-JJJ.

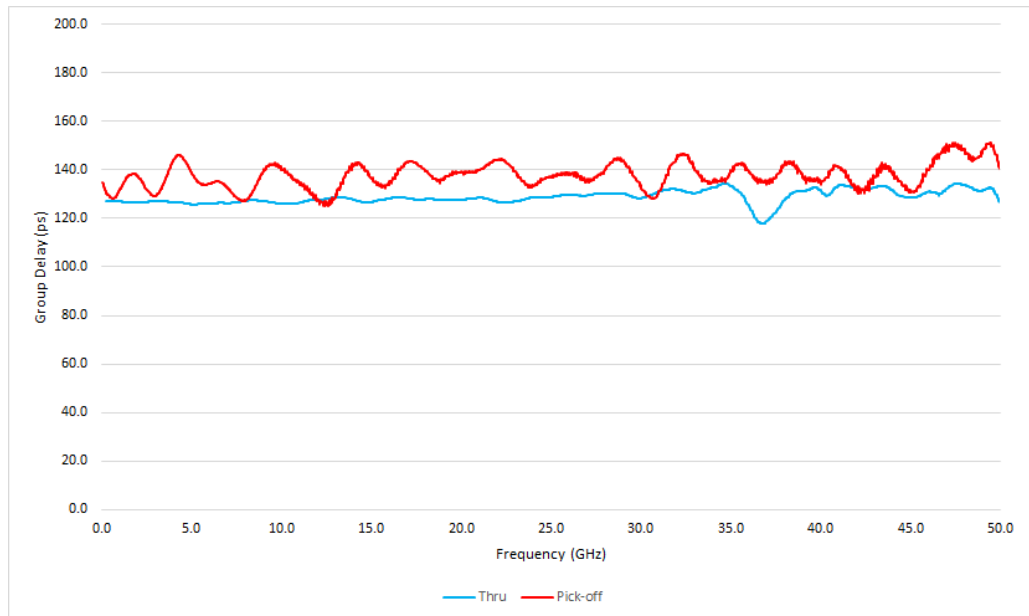

Figure 8: Typical HL9565-U-14-JJJ group delay along the thru and pick-off lines

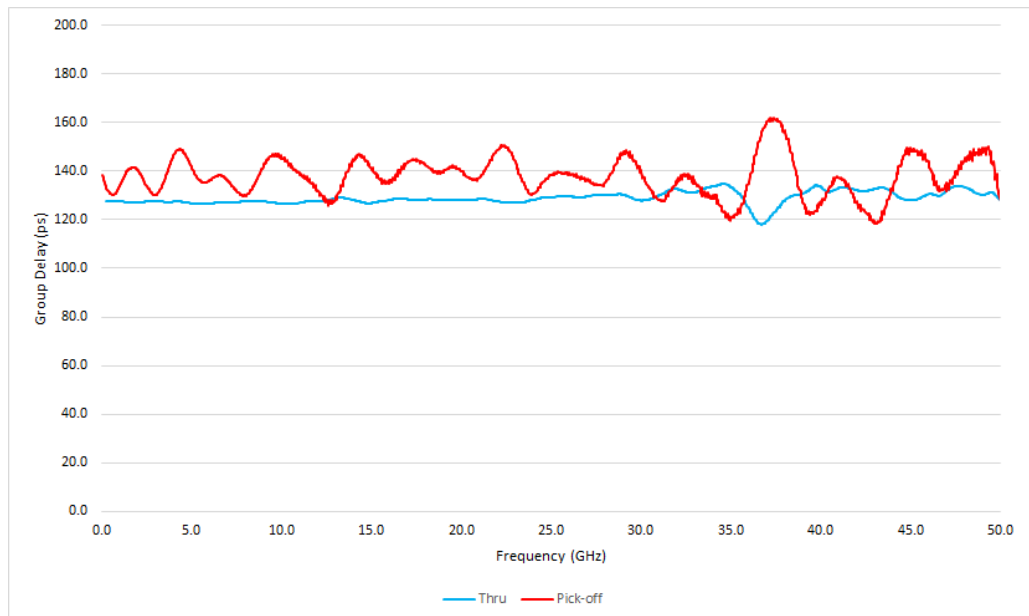

Figure 9: Typical HL9565-U-20-JJJ group delay along the thru and pick-off lines

HL9565 VSWR

Figure 10 shows the typical VSWR of the HL9565-U-14-JJJ for all ports from DC to 50 GHz.

Figure 11 shows the same measurements on an HL9565-U-20-JJJ.

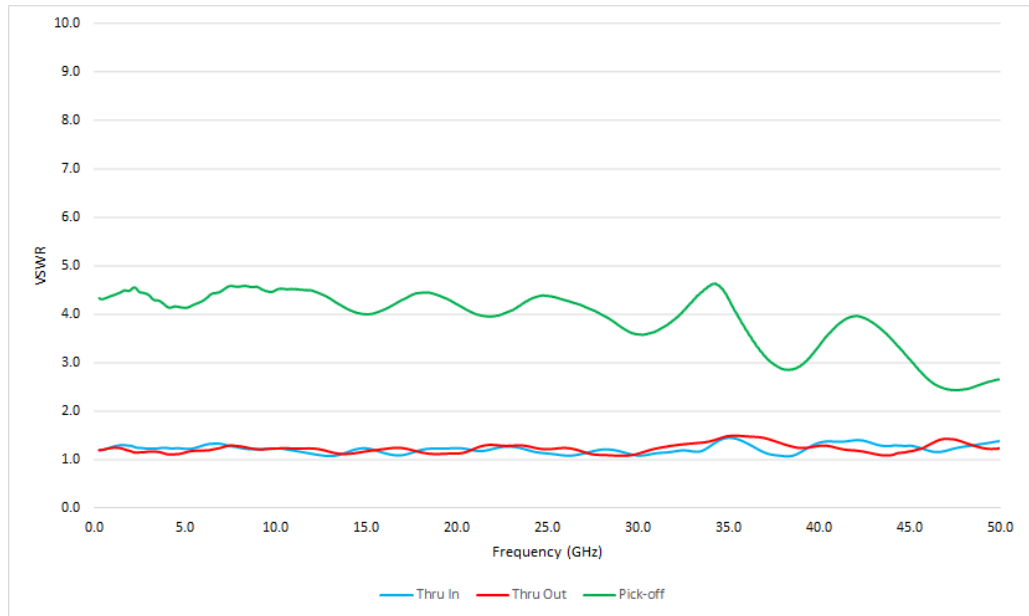

Figure 10: Typical HL9565-U-14-JJJ VSWR on all ports



Figure 11: Typical HL9565-U-20-JJJ VSWR on all ports