

HL9408 Broadband Balun (500 kHz to 85 GHz)

Features and Technical Specifications¹

Bandwidth	500 kHz to 85 GHz (3 dB)
Amplitude Match See Fig. 1	± 0.2 dB, $f \leq 50$ GHz ± 0.5 dB, $f > 50$ GHz
Phase Match See Fig. 4	$\pm 4^\circ$, $f = 20$ GHz $\pm 5^\circ$, $f = 40$ GHz $\pm 15^\circ$, $f = 80$ GHz
Insertion Loss See Fig. 1	6.5 dB, single-ended reference
Return Loss See Fig. 2	> 15 dB, unbal. port, $f \leq 60$ GHz > 10 dB, unbal. port, $60 \text{ GHz} < f \leq 85 \text{ GHz}$ > 10 dB, bal. ports, $f \leq 60$ GHz > 7.5 dB, bal. ports, $60 < f \leq 85 \text{ GHz}$
Rise Time	4.1 ps
Group Delay See Fig. 3	≈ 270 ps
Max Input Power	1 W (+30 dBm)
Impedance	50 Ω
Connectors	1.0 mm, 3 x jack/female (standard config)
Dimensions (W x D x H)	1.967" x 1.40" x 0.40" 50.0 x 35.6 x 10.2 mm
Weight	45.3 g (1.6 oz.)
Temperature Limits	-40° to +100° C, operating
RoHS Compliant	Yes, assembled with lead-free solder
REACH Compliant	Yes
Warranty	1 year, see website

Note 1 - All specifications based on test results using standard connector configuration (3 x jack).

PRODUCT SUMMARY

The HL9408 is an ultra-broadband 180° signal splitter and combiner that offers excellent amplitude and phase match over a bandwidth of 500 kHz to 85 GHz.

It is suitable for use in 112 Gbps PAM4 communications systems, high-speed analog-to-digital conversion, frequency response testing for differential devices, and many other applications.

DEPLOYMENT NOTES

When the device is used as a signal combiner using differential signals with unmatched source impedance, attenuators (3-6 dB) may be required to improve isolation.

If the DC voltage of the balanced or unbalanced ports is non-zero, DC blocks are required. The balanced ports (2 and 3) are DC shorted.

MODELS

The following model is available:

HL9408, 85 GHz

The following connector option is available:

-JJJ, jack/jack/jack



HL9408, standard configuration shown

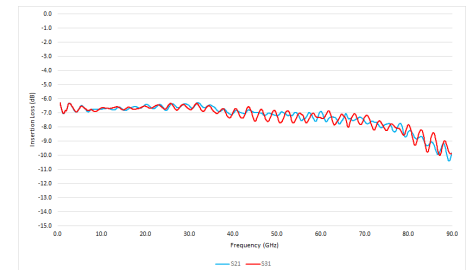

Typical HL9408 Single-ended Insertion Loss

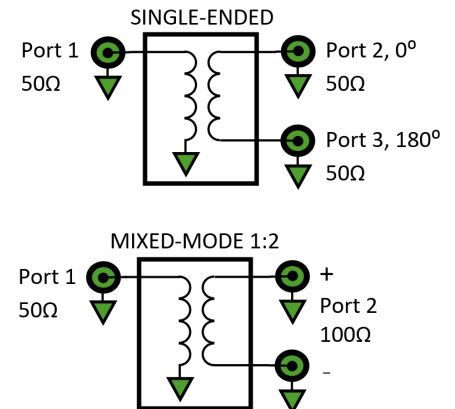

HL9408 Schematic and Port Assignments

HL9408 Plot Diagrams

Figures 1-4 show the typical S-parameter characteristics in single-ended mode. Unless otherwise noted, bandwidth for all HYPERLABS baluns is defined as the range of frequencies where insertion loss is within 3 dB of the nominal level (6.5 dB) in single-ended mode.

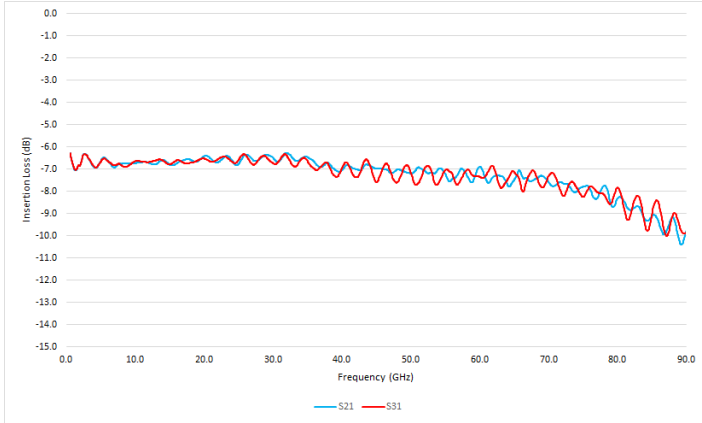

Figure 1: HL9408 Single-ended Insertion Loss and Amplitude Match

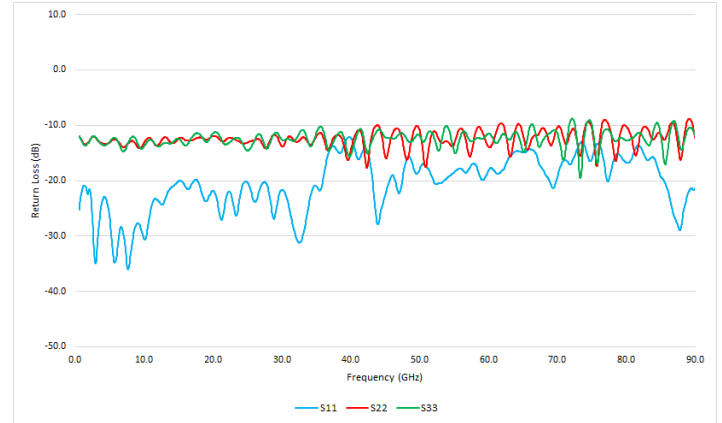

Figure 2: HL9408 Single-ended Return Loss

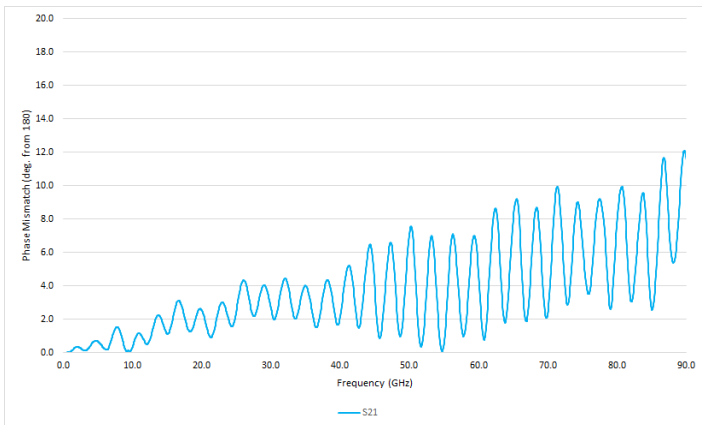

Figure 3: HL9408 Phase Mismatch

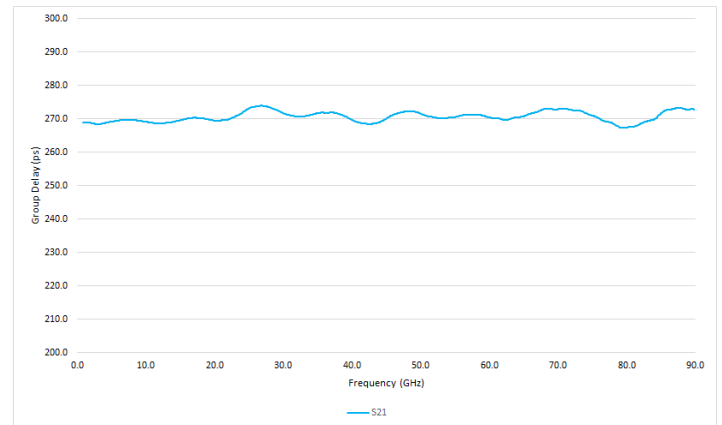

Figure 4: HL9408 Group Delay

HL9408 Dimensional Drawing

Figure 5 shows a mechanical drawing of an HL9408. Unless otherwise noted, all units are in inches. See page 1 for full dimensions.

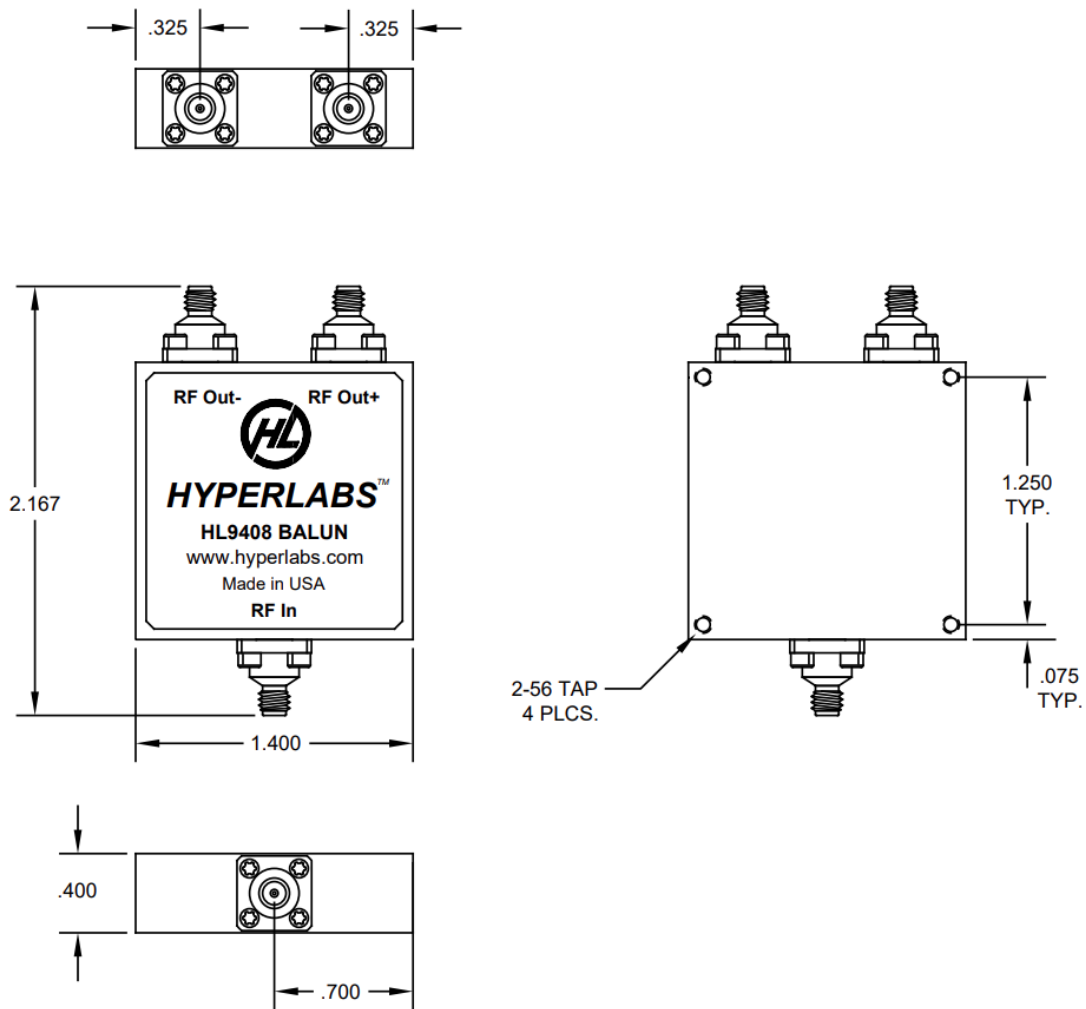

Fig. 5: HL9408 Mechanical Drawing