

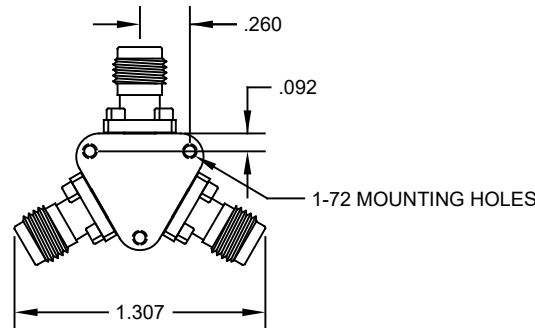
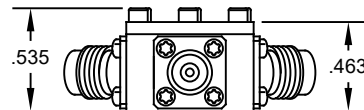
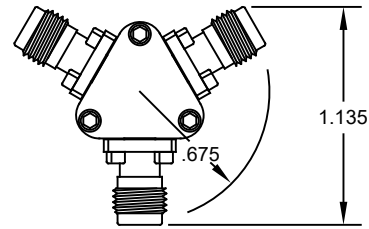

CONFIDENTIAL

THIS DOCUMENT, OR DATA DISCLOSED HEREIN, IS NOT TO BE REPRODUCED, USED, OR DISCLOSED, IN WHOLE OR PART, TO ANYONE WITHOUT THE DIRECT PERMISSION OF HYPERLABS, INC.

REVISIONS

ECN #	REV	DESCRIPTION	DATE	RELEASED BY
XXXX	0	ORIGINAL	04/09/20	JJY



SCALE: 1:1	P SCALE: 1	MATERIAL: N/A		
TOLERANCES UNLESS OTHERWISE NOTED: INCHES X.X ± 0.1 X.XX ± 0.01 X.XXX ± 0.005 X.XXXX ± 0.0005 X" ± 1"	DRAWN BY	JJY	INITIAL	DATE
	DESIGN ENG			04/09/20
	MATERIALS			
	PROD ENG			
	QUALITY			
		 HYPERLABS, Inc. 13830 SW Rawhide Court, Beaverton OR 97008		
		TITLE: HL9477 POWER DIVIDER, 1.85mm CONNECTOR		
		PART #: 400062		SIZE: A
		DRAWING #: 400062		REV: 0 PAGE 1 OF 1

NOTES:

1. DIMENSIONS IN INCHES UNLESS OTHERWISE NOTED