

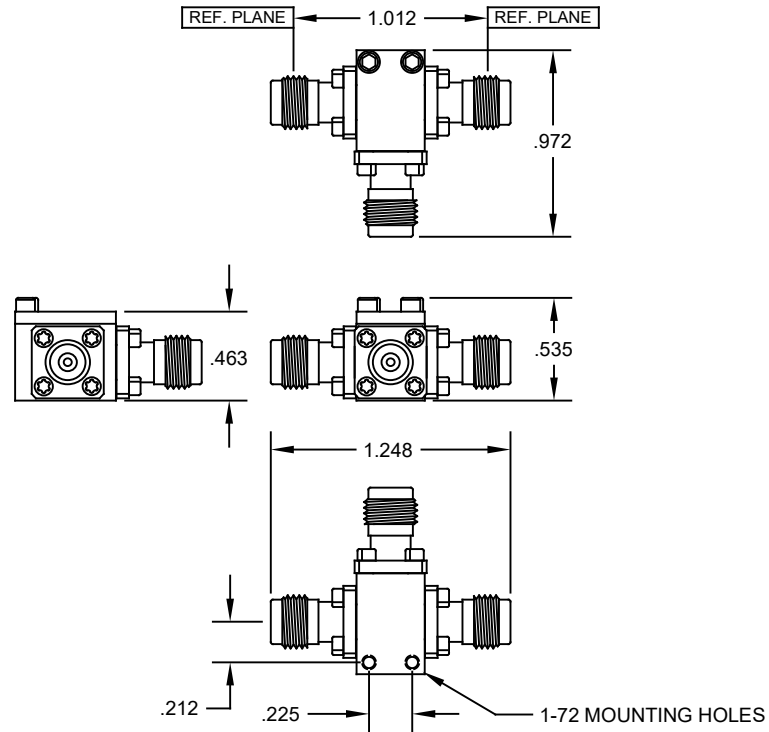

CONFIDENTIAL

THIS DOCUMENT, OR DATA DISCLOSED HEREIN, IS NOT TO BE REPRODUCED, USED, OR DISCLOSED, IN WHOLE OR PART, TO ANYONE WITHOUT THE DIRECT PERMISSION OF HYPERLABS, INC.

REVISIONS				
ECN #	REV	DESCRIPTION	DATE	RELEASED BY
0563	0	ORIGINAL	10/31/18	AA
XXXX	1	REMOVED WEIGHT	04/10/20	JJY



SCALE: 1:1	P SCALE: 1	MATERIAL: N/A		
TOLERANCES UNLESS OTHERWISE NOTED: INCHES X.X ± 0.1 X.XX ± 0.01 X.XXX ± 0.005 X.XXXX ± 0.0005 X" ± 1"	DRAWN BY	DDP	DATE	10/31/18
	DESIGN ENG			
	MATERIALS			
	PROD ENG			
	QUALITY			
		 HYPERLABS, Inc. 13830 SW Rawhide Court, Beaverton OR 97008		
		TITLE: HL9468-47 PICKOFF TEE, 1.85mm CONNECTOR, FEMALE OUTPUT		
		PART #: N/A		SIZE: A
		DRAWING #: 400051		REV: 1 PAGE 1 OF 1

NOTES:

1. DIMENSIONS IN INCHES UNLESS OTHERWISE NOTED